

PPV - PPV80

Adjustable upper plate

LAUMAS[®]
ELETTRONICA

For SINGLE POINT, BENDING BEAM, SHEAR BEAM and COMPRESSION load cells

Application range from 10 to 5000 kg



PPV

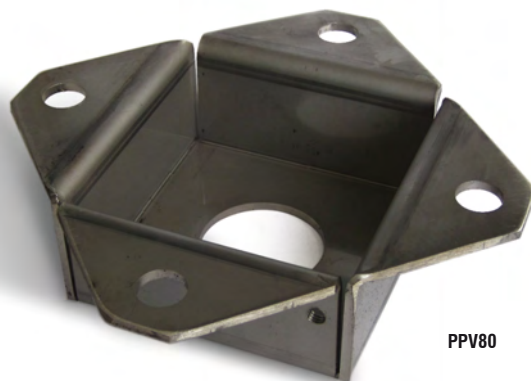

PPV80



DESCRIPTION

- AISI 304 stainless steel plates for constraint against lateral forces and anti-tilt.
- For self-centring joint foot.

MAX STATIC LOAD kg	NET WEIGHT OF PLATE (kg)	CODE
2000	0.2	PPV
5000	0.6	PPV80

DIMENSIONS (mm)

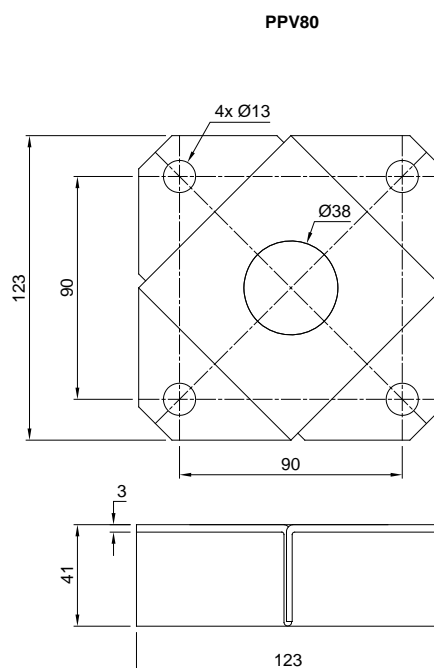
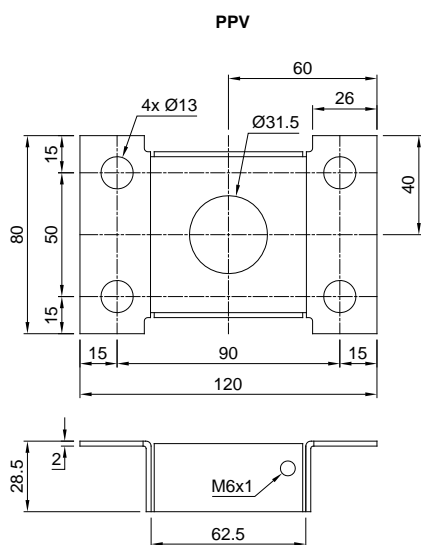

The Company reserves the right to make changes to the technical data, drawings and images without notice.